

# **The Art of Science Coloring Book**

Waters

THE SCIENCE OF WHAT'S POSSIBLE.™

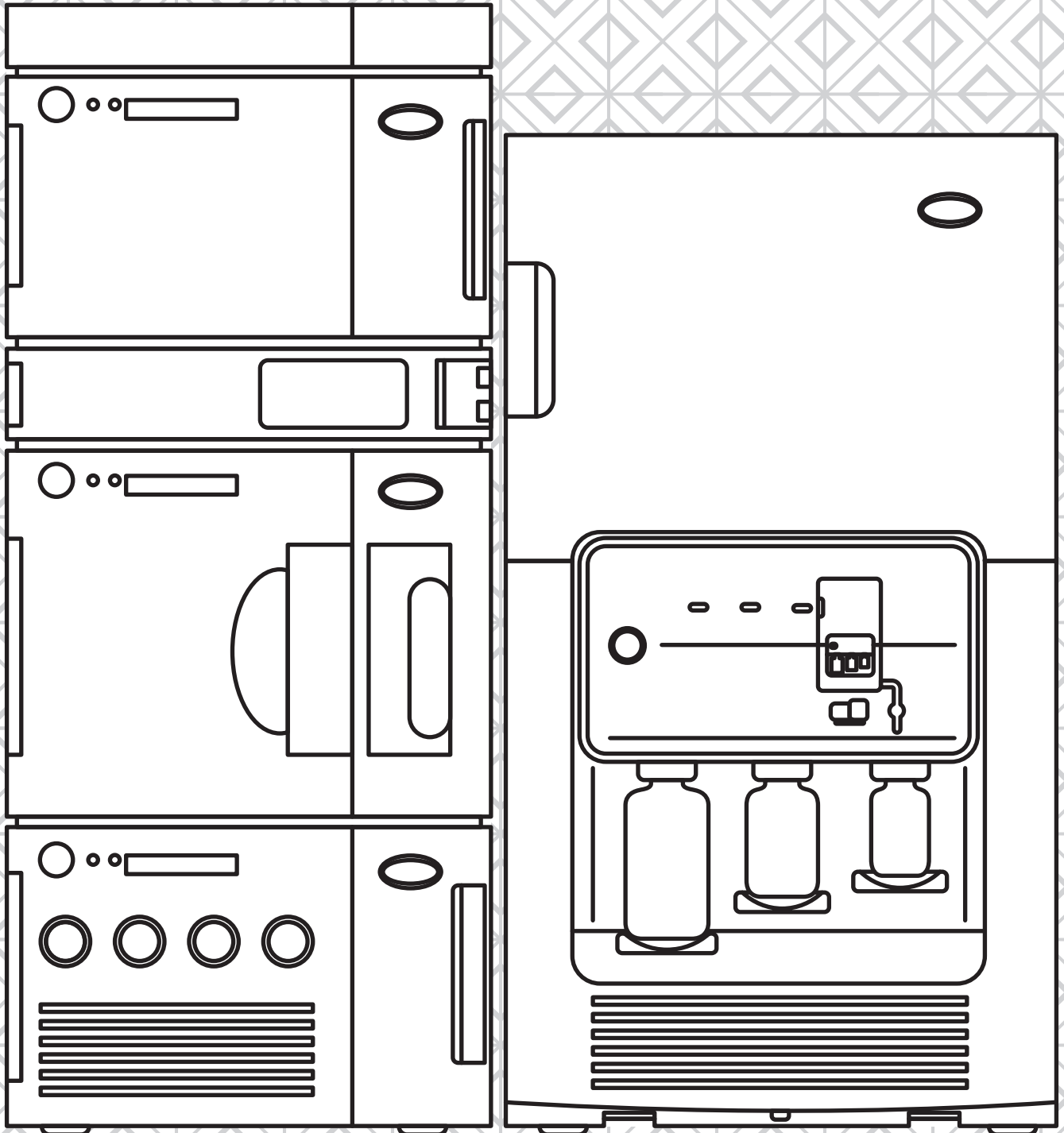

Waters

THE SCIENCE OF WHAT'S POSSIBLE.™

[www.waters.com/bioaccord](http://www.waters.com/bioaccord)

BioAccord<sup>™</sup>  
SYSTEM

720006839EN

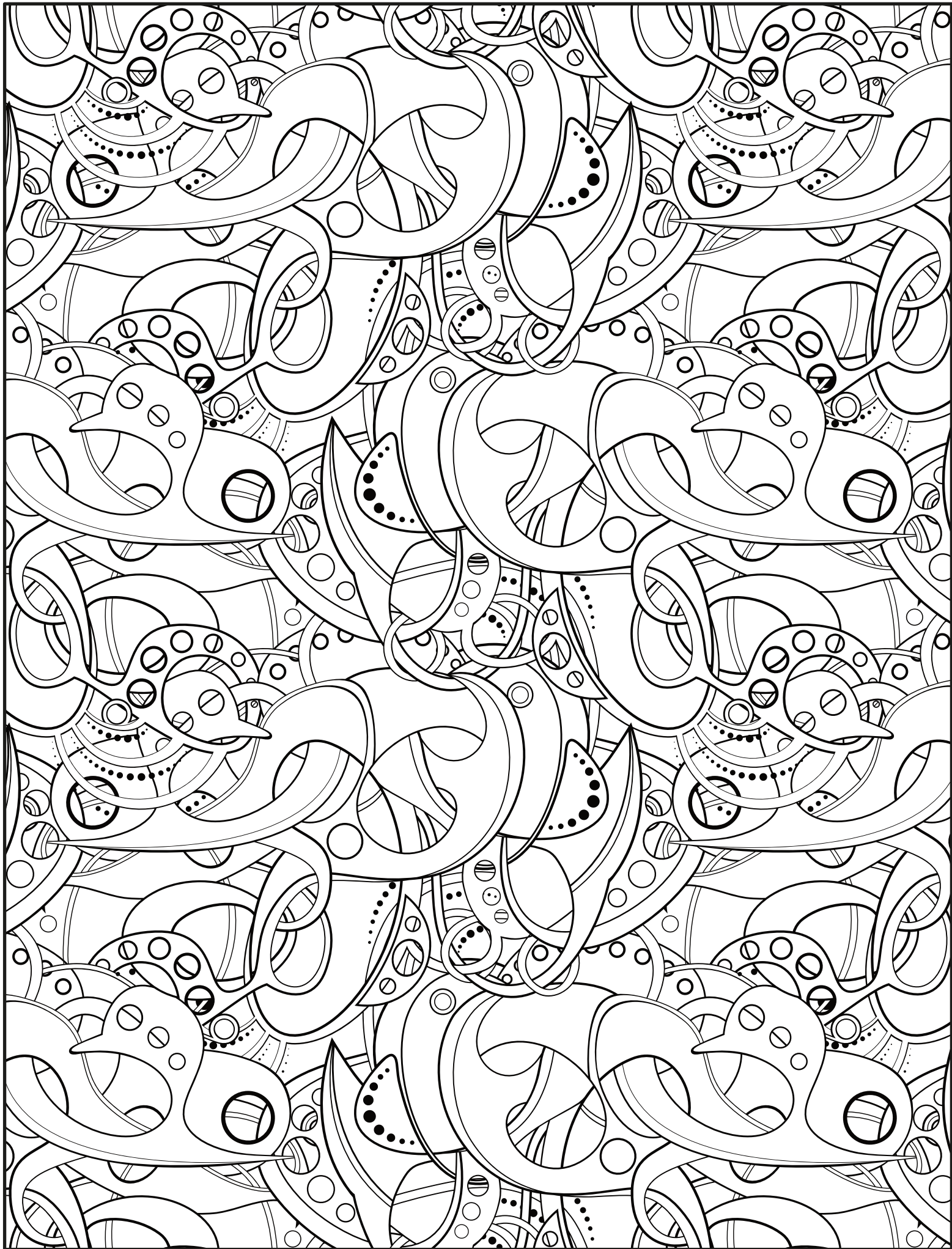



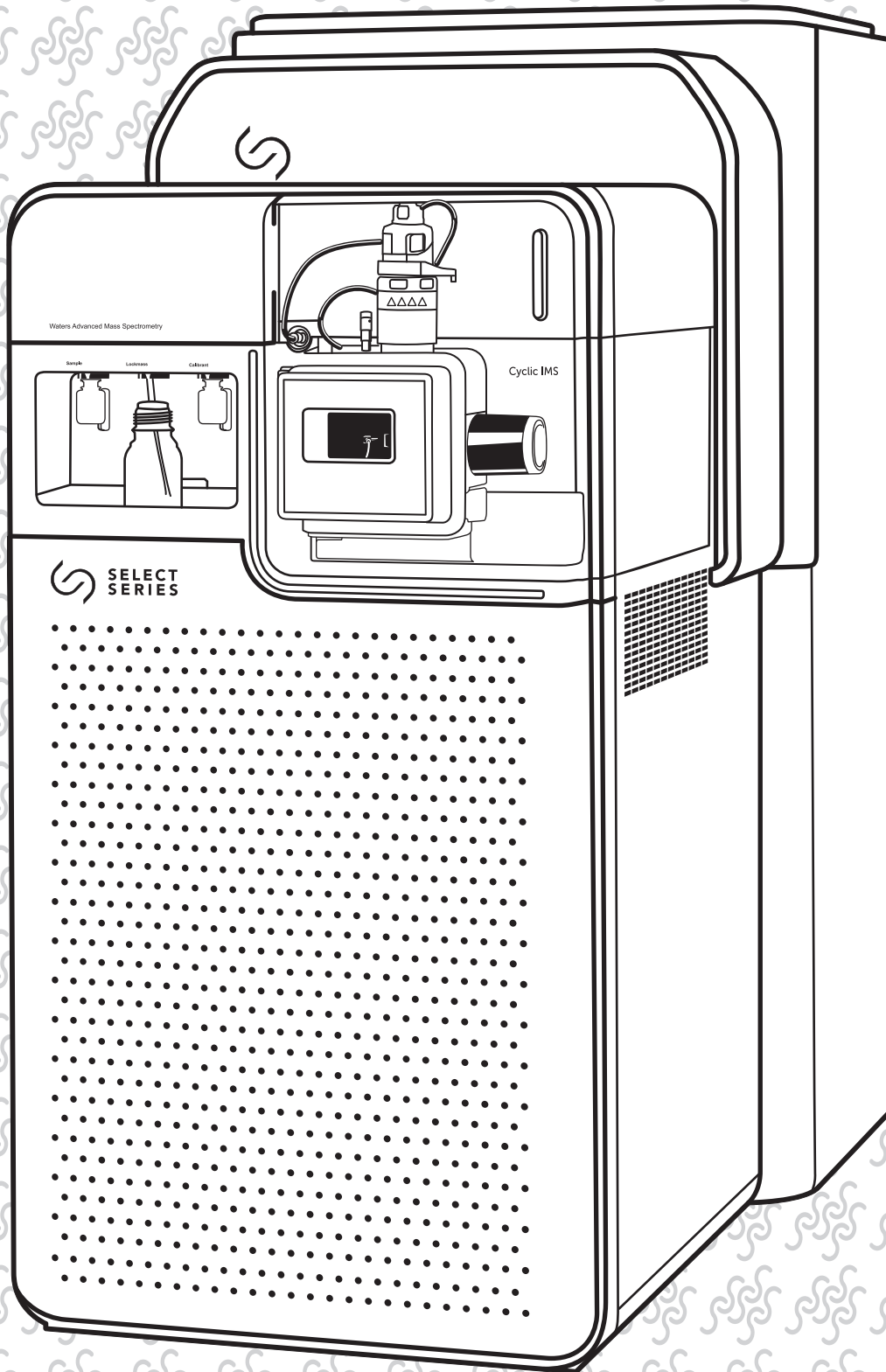

Waters

THE SCIENCE OF WHAT'S POSSIBLE.™

[www.waters.com/cyclicims](http://www.waters.com/cyclicims)

720006904EN



SELECT  
SERIES



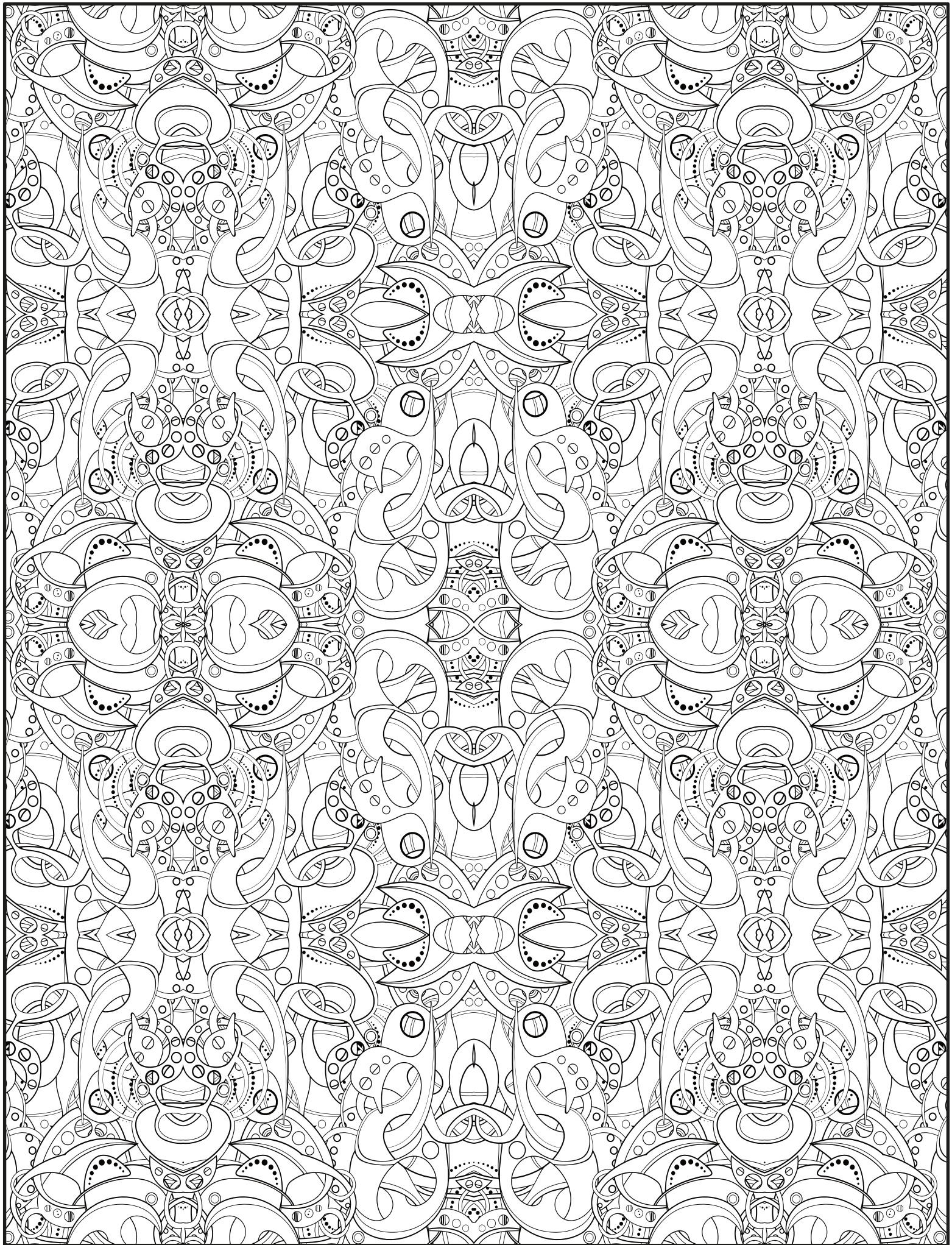

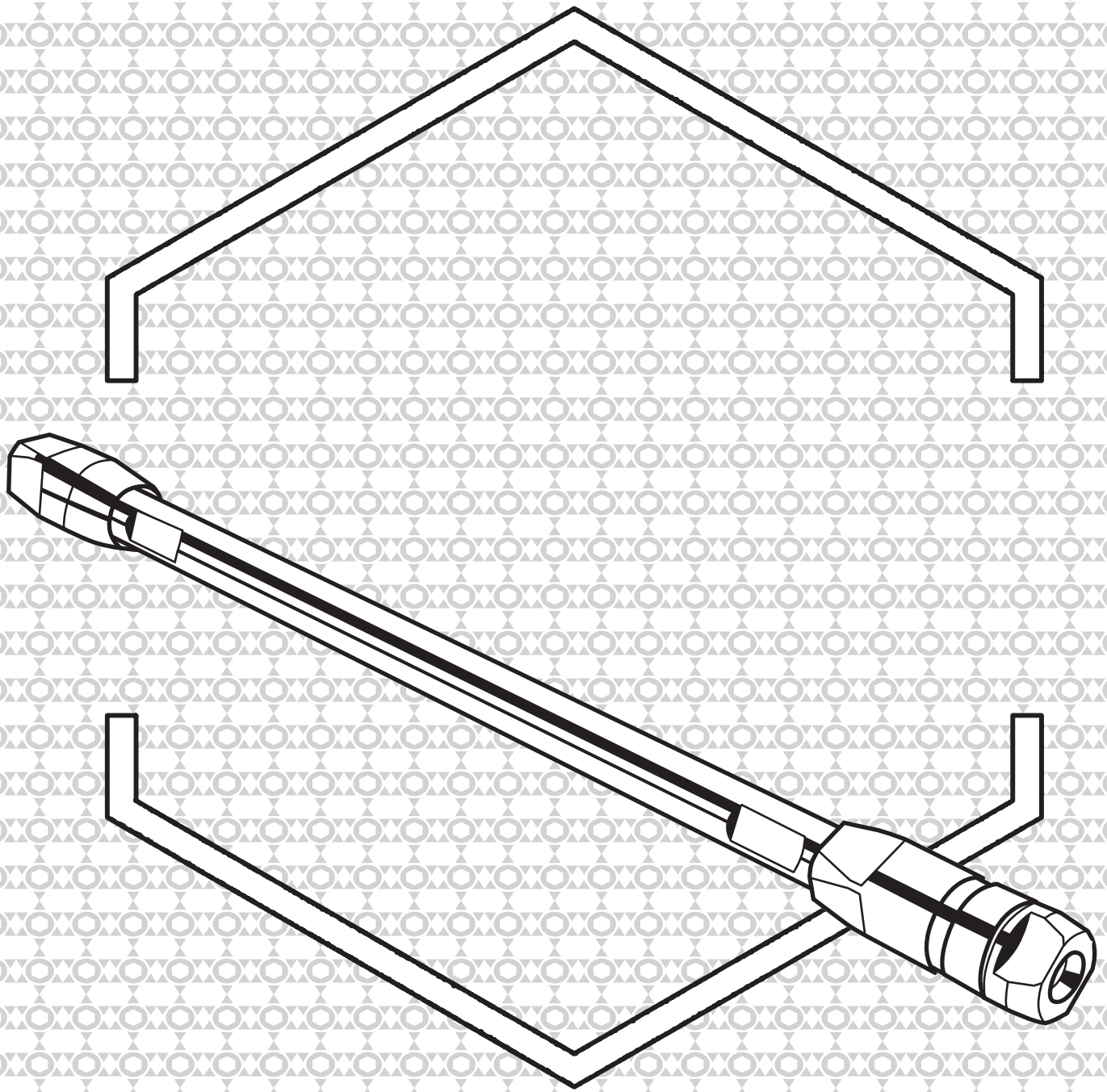

Waters

THE SCIENCE OF WHAT'S POSSIBLE.™

[www.waters.com/premier](http://www.waters.com/premier)



720006903EN

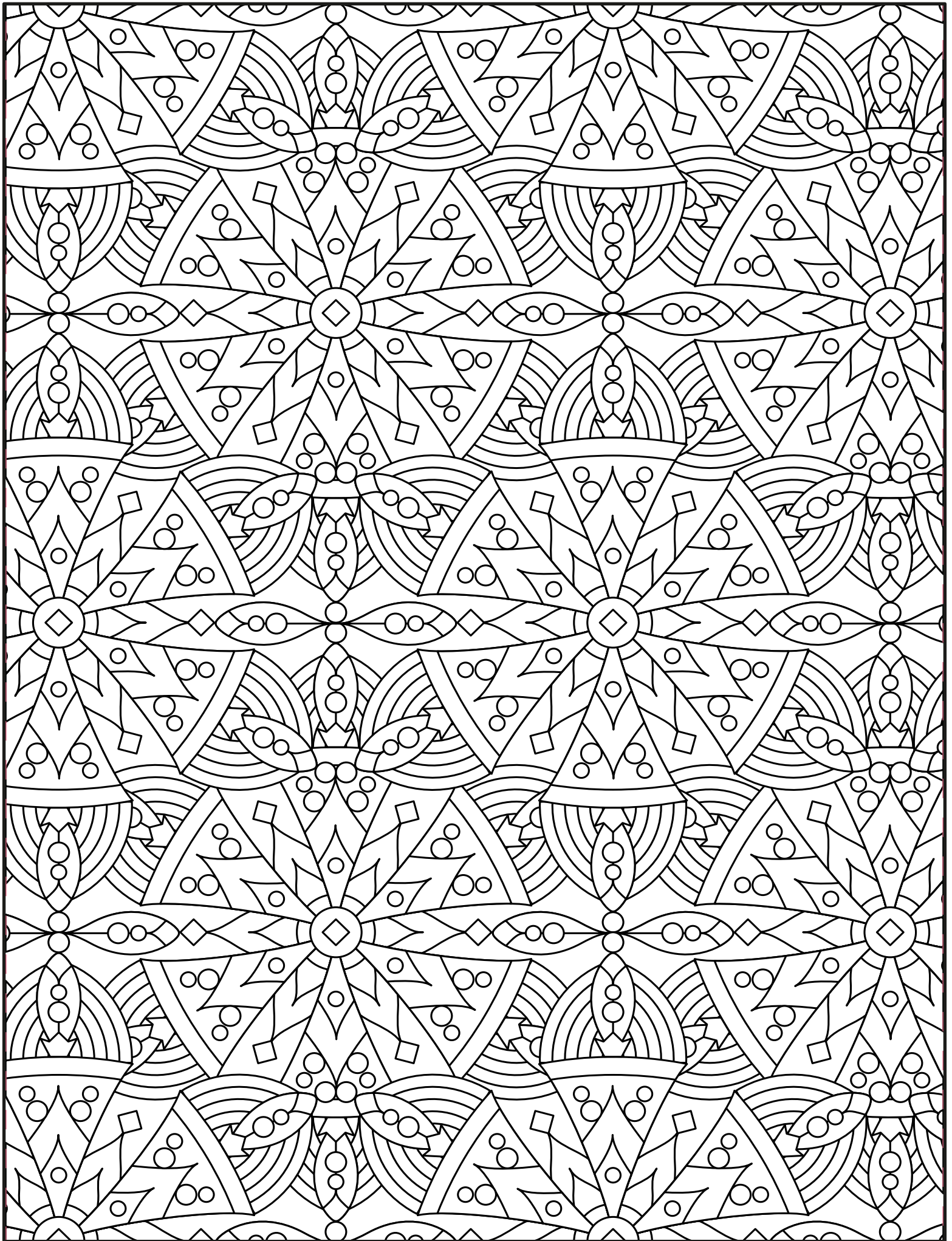



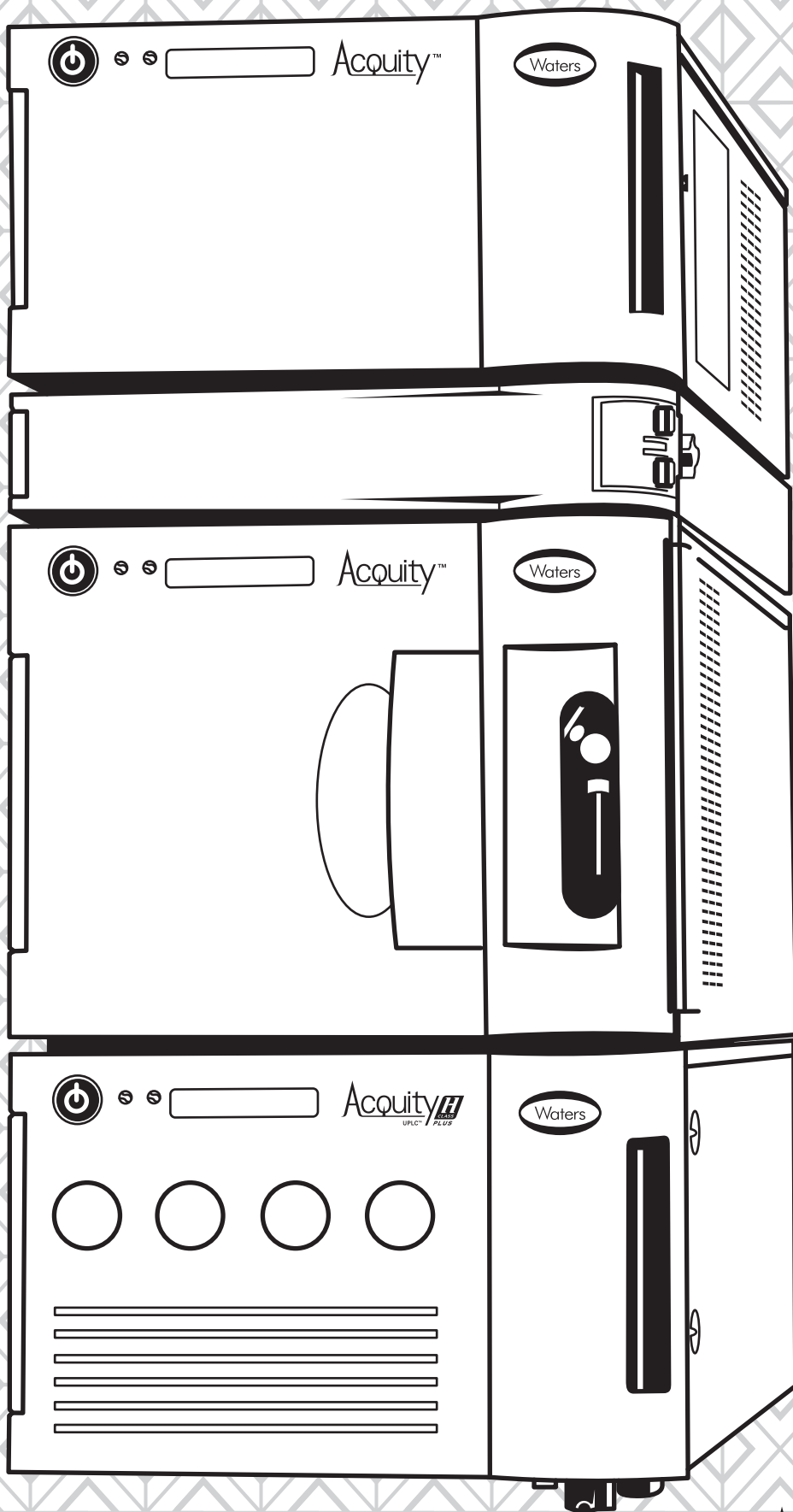

Waters

THE SCIENCE OF WHAT'S POSSIBLE.™

[www.waters.com/uplc](http://www.waters.com/uplc)

Acquity **H**  
UPLC™ CLASS PLUS

720006837EN

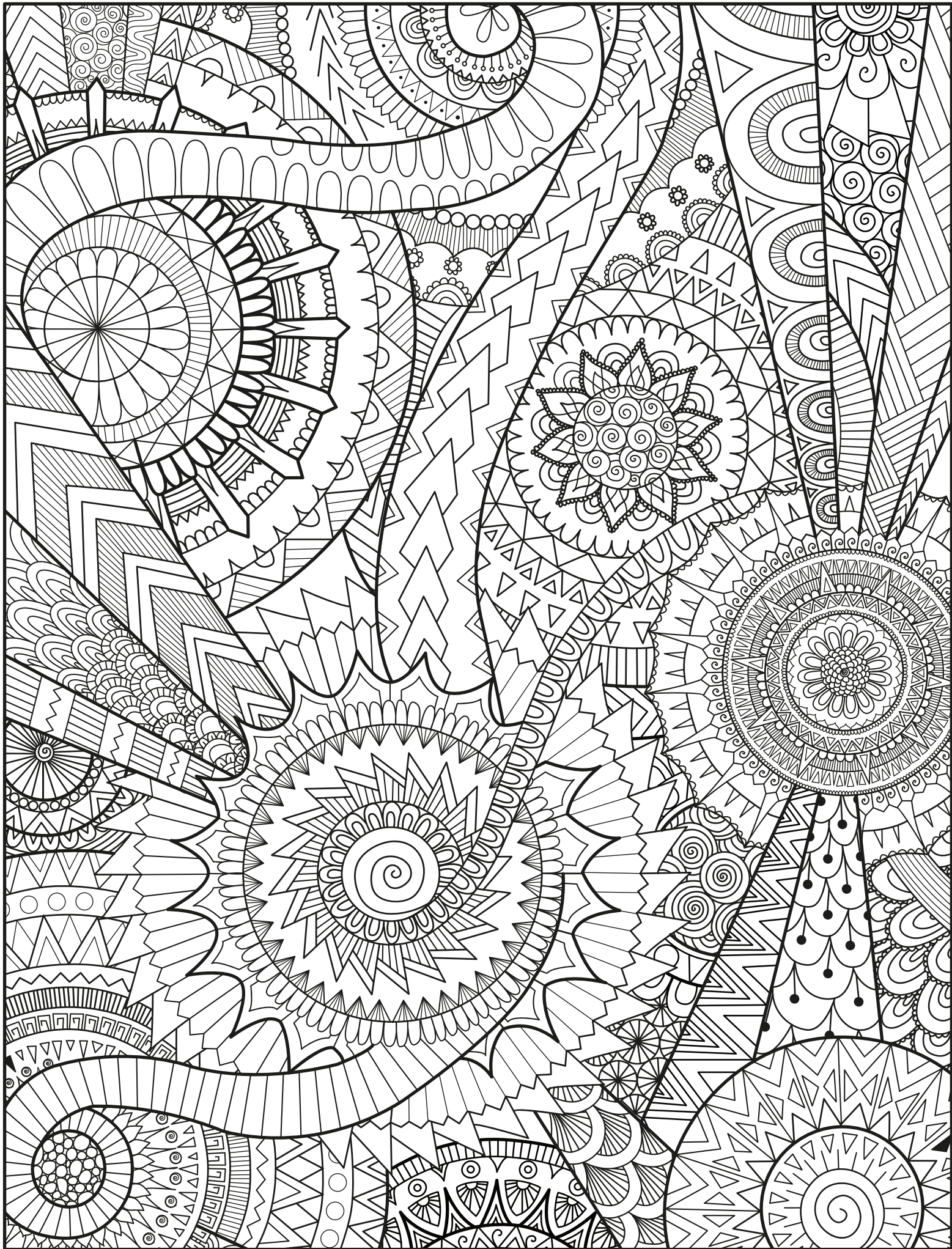

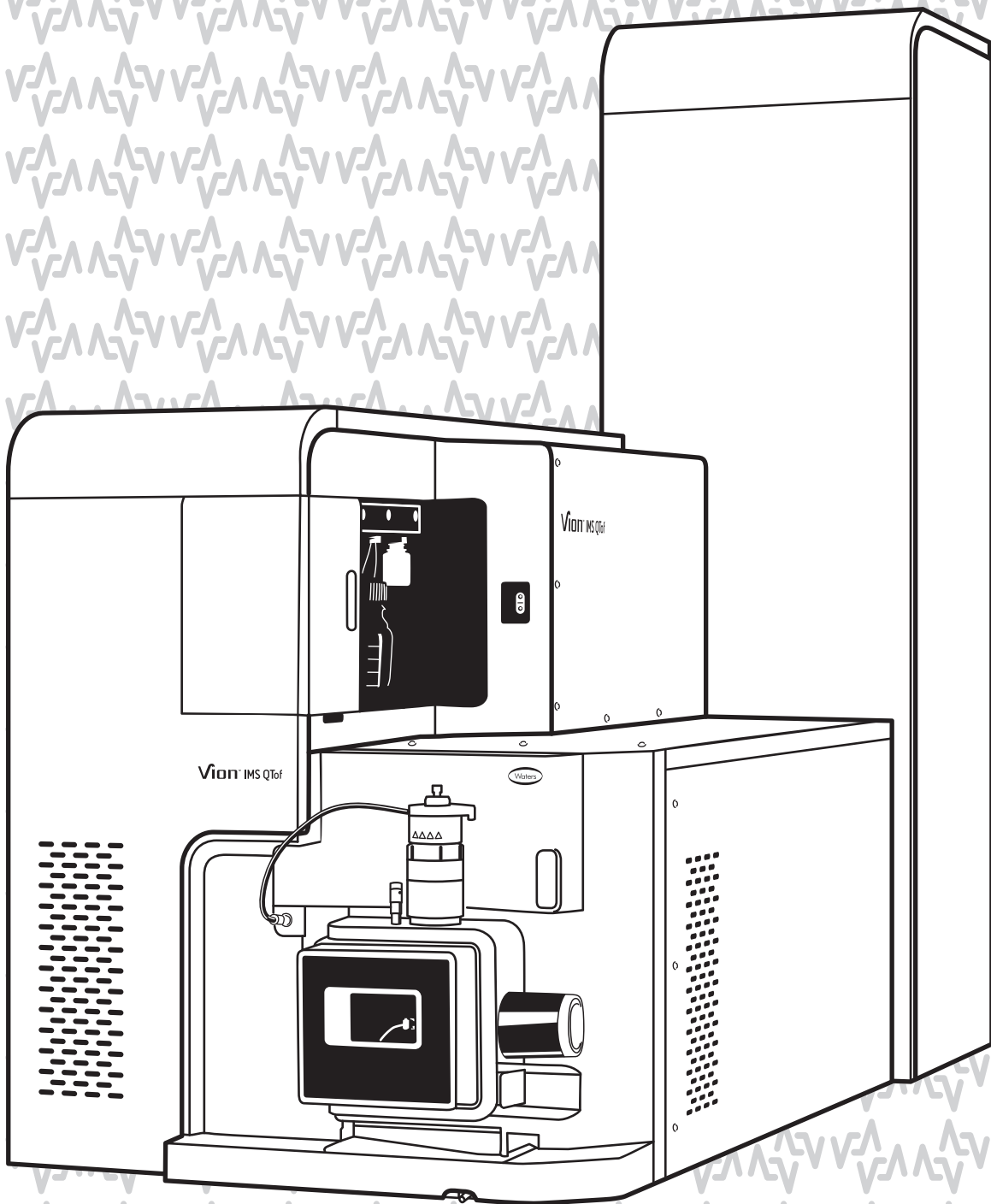

Waters

THE SCIENCE OF WHAT'S POSSIBLE.™

[www.waters.com/vion](http://www.waters.com/vion)

Vion™ IMS QToF

720006902EN



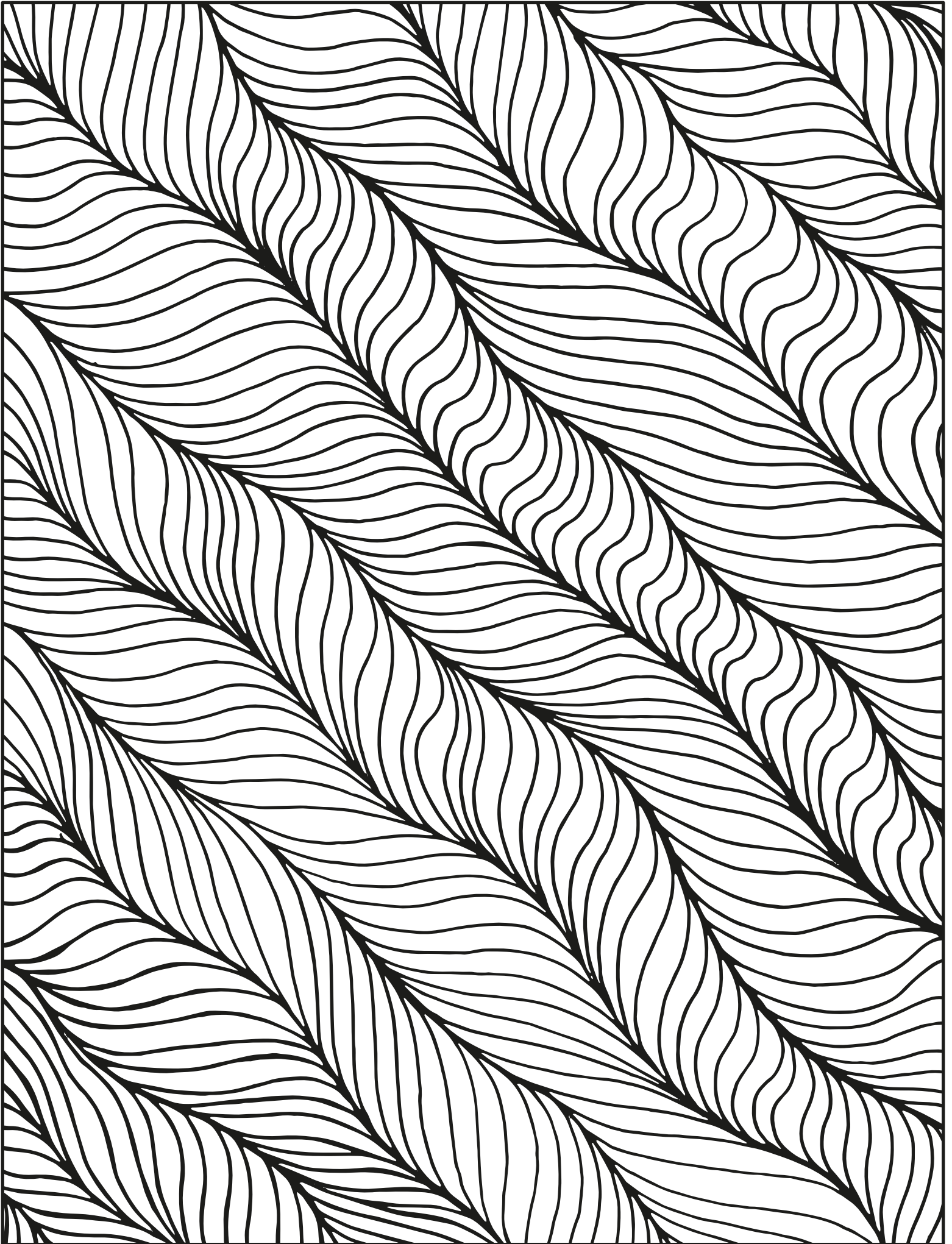

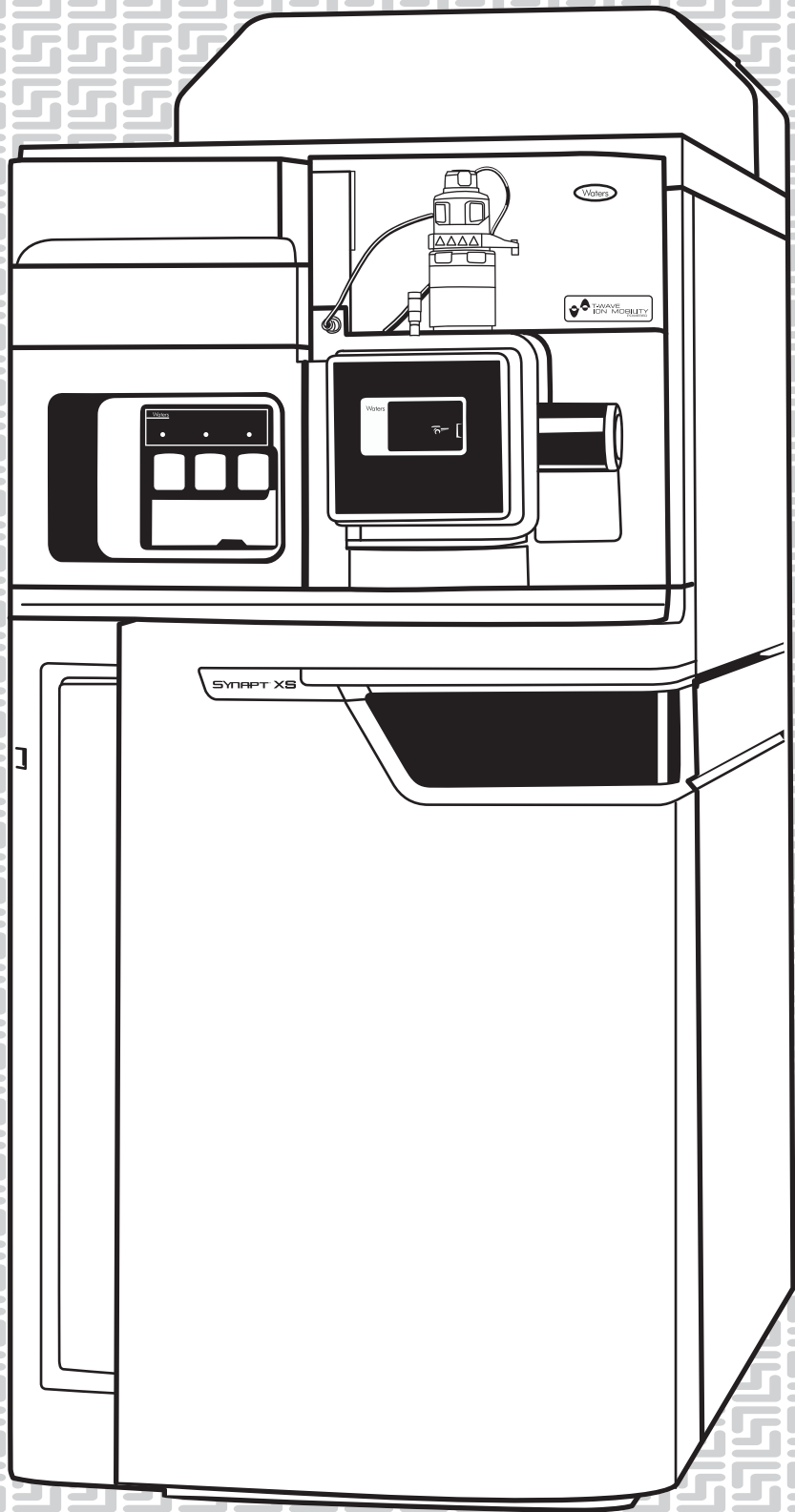

Waters

THE SCIENCE OF WHAT'S POSSIBLE.™

[www.waters.com/synaptxs](http://www.waters.com/synaptxs)

**SYNAPT™ XS**

720006901EN

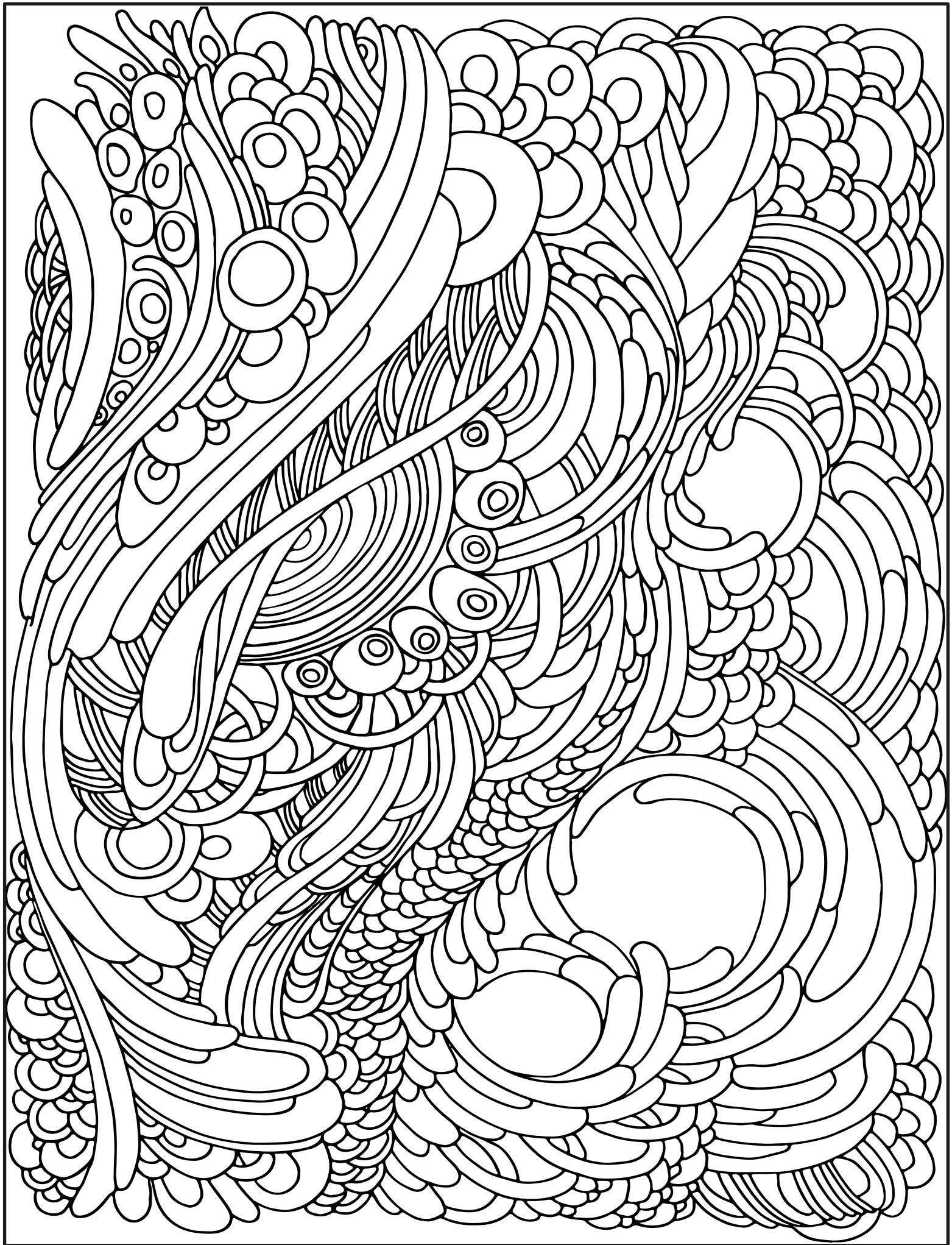



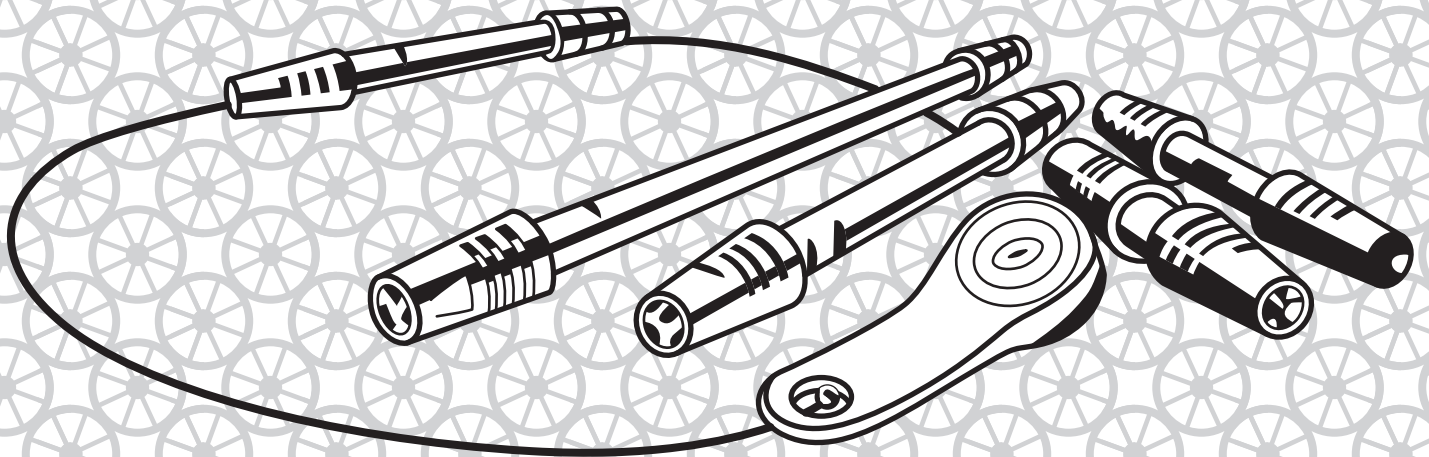

Waters

THE SCIENCE OF WHAT'S POSSIBLE.™

[www.waters.com/cortecs](http://www.waters.com/cortecs)

**CORTECS**™  
COLUMNS

72006840EN

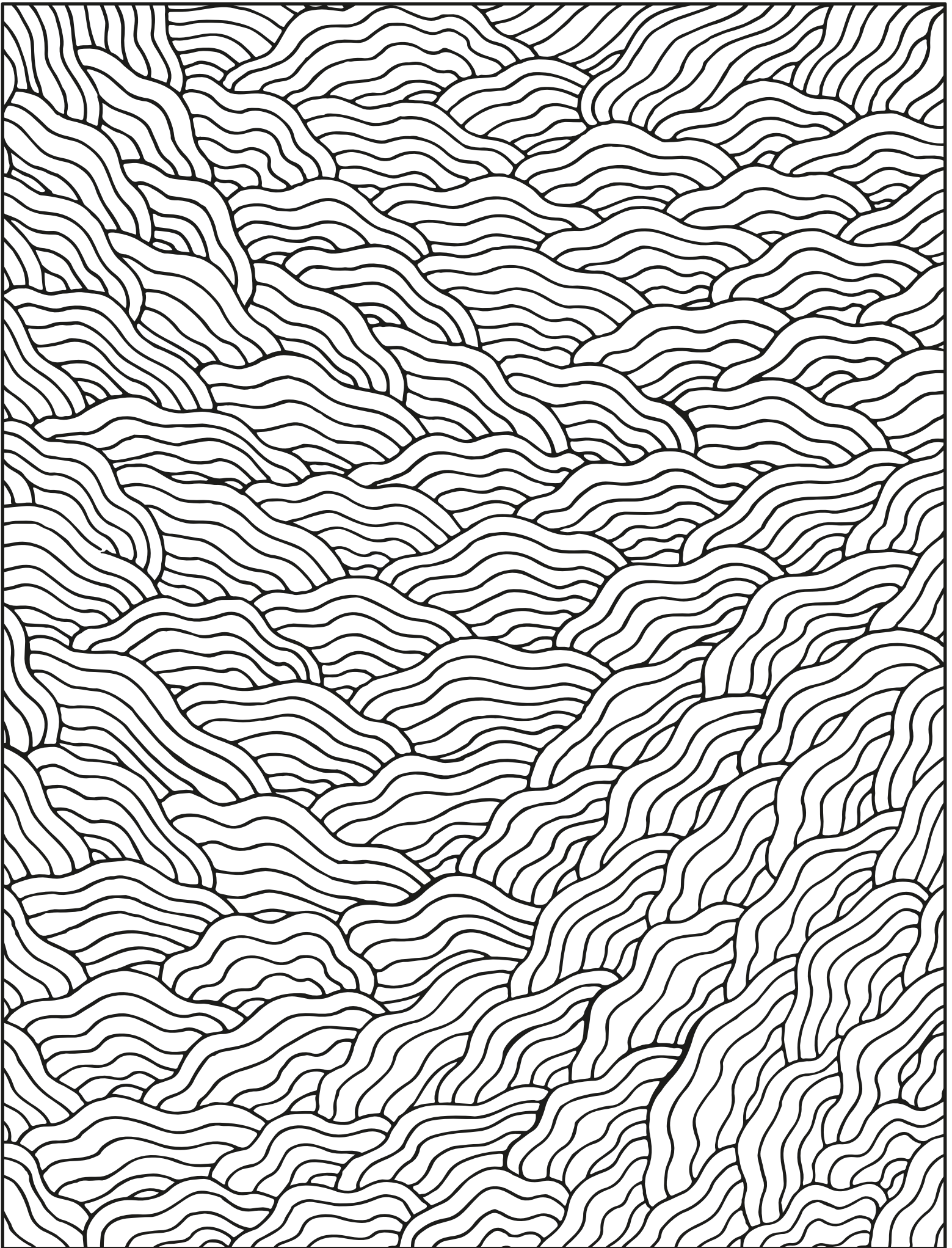

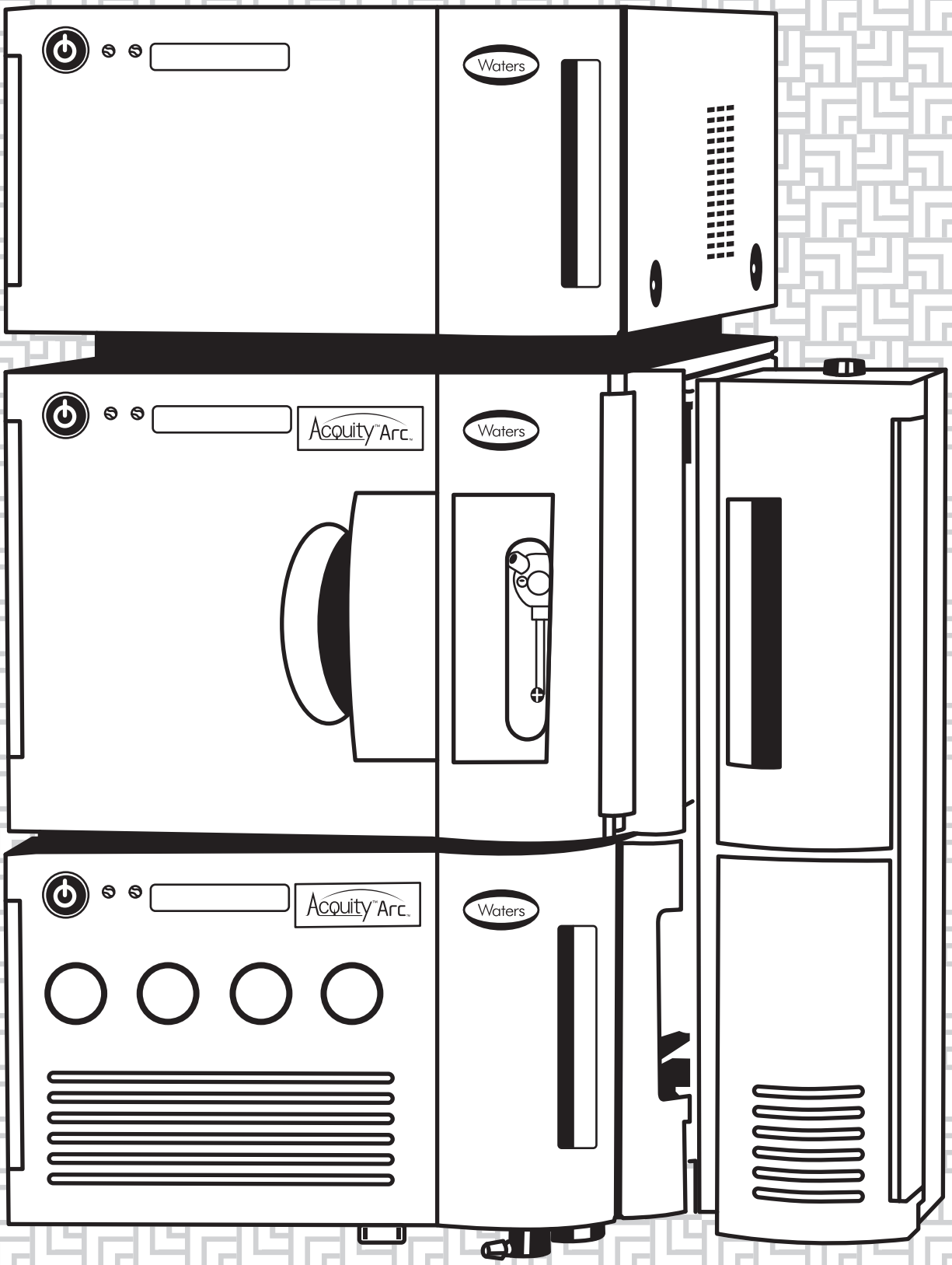

Waters

THE SCIENCE OF WHAT'S POSSIBLE.™

[www.waters.com/arc](http://www.waters.com/arc)

Acquity™ Arc™

720006835EN

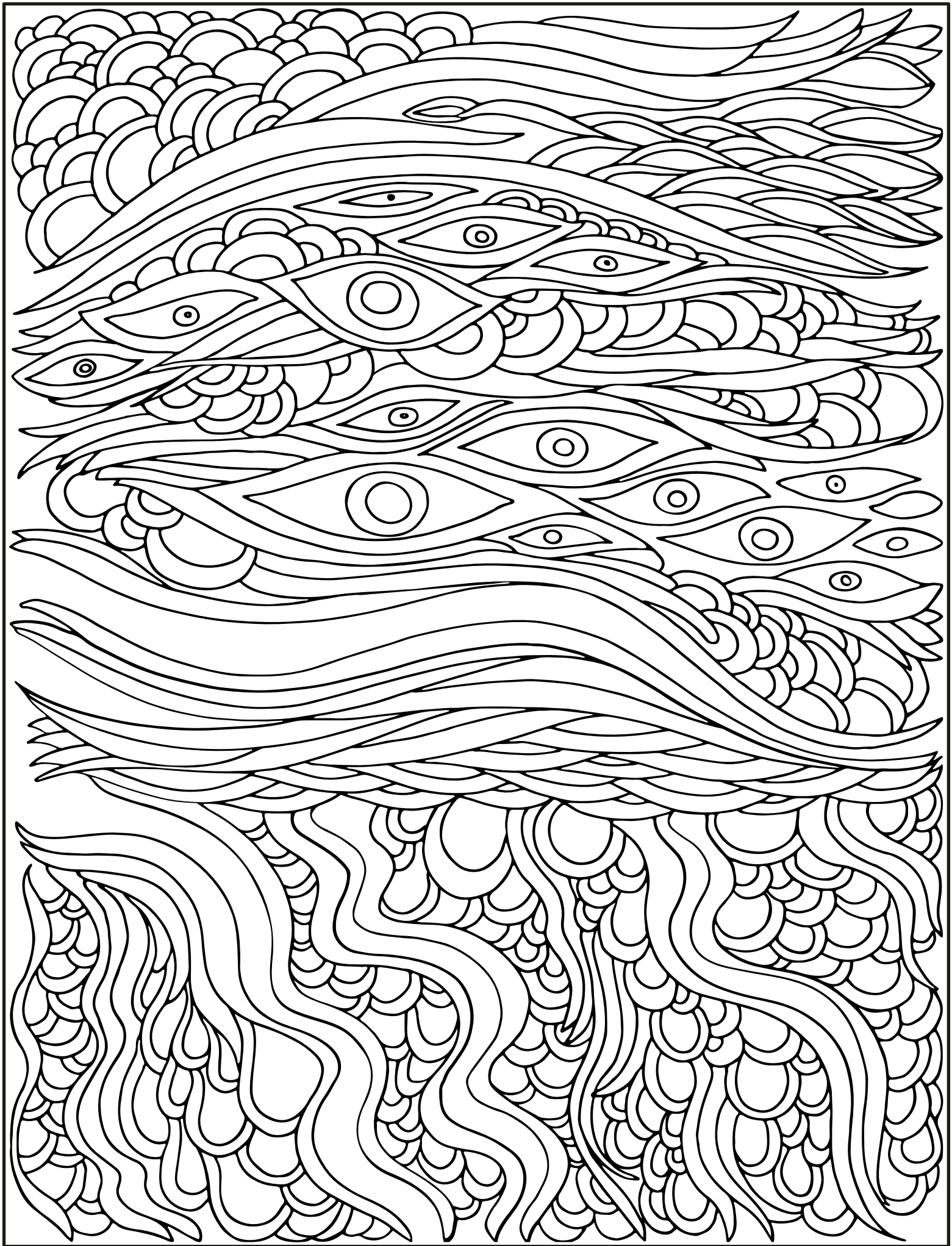



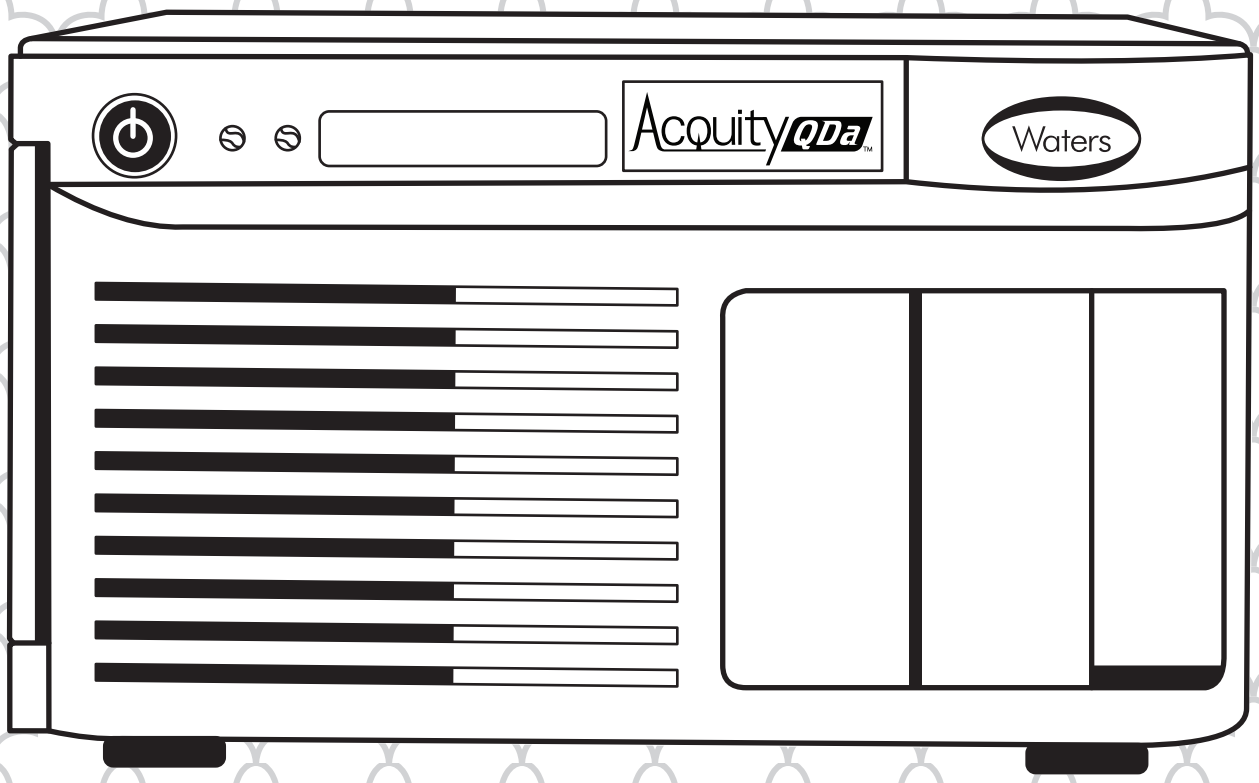

Waters

THE SCIENCE OF WHAT'S POSSIBLE.™

[www.waters.com/qda](http://www.waters.com/qda)

Acquity **QDa**™

720006836EN

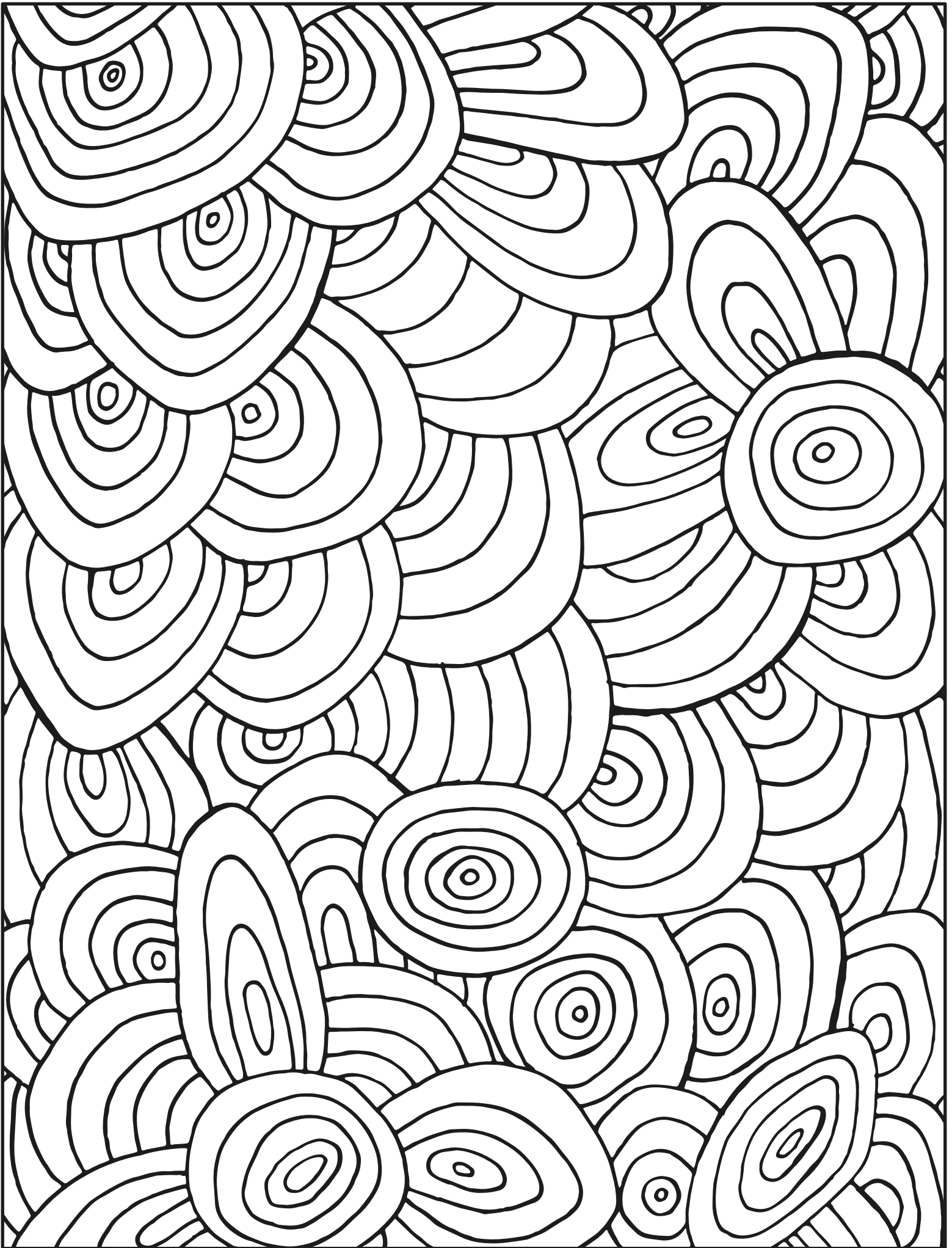

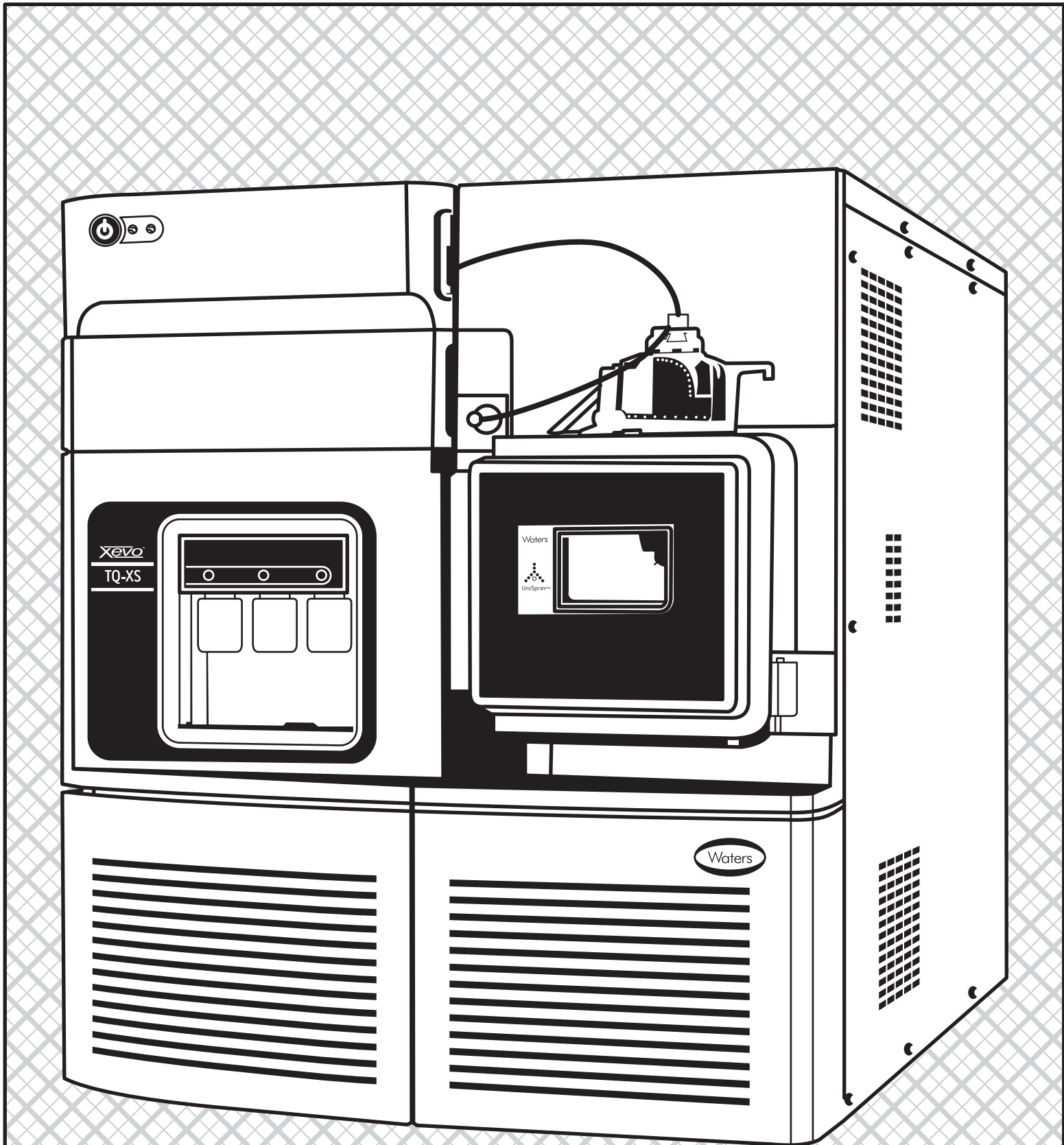

Waters

THE SCIENCE OF WHAT'S POSSIBLE.™

[www.waters.com/xevo](http://www.waters.com/xevo)

**Xevo™ TQ-XS**

720006841EN





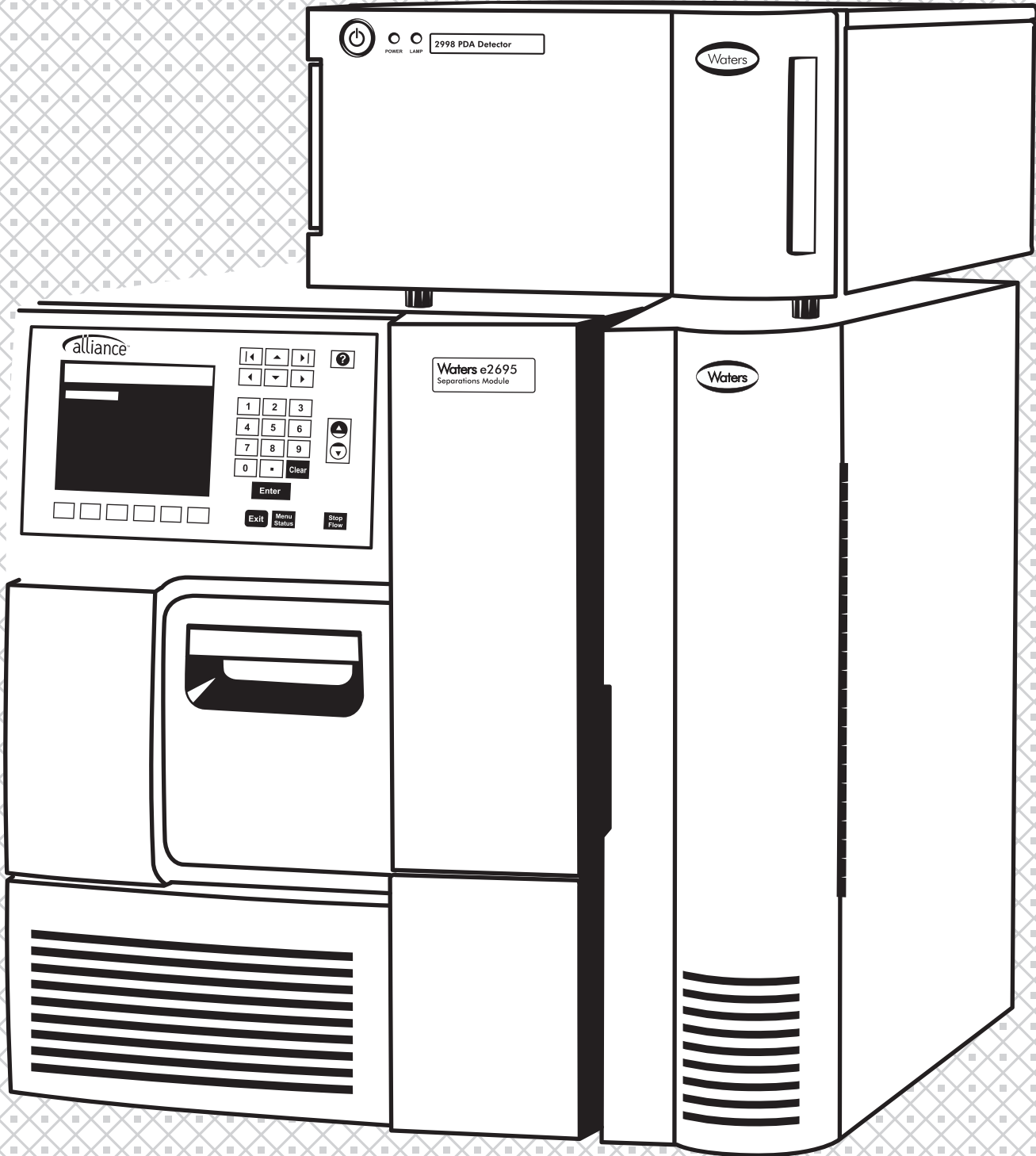

POWER LAMP 2998 PDA Detector

Waters

alliance

1 2 3  
4 5 6  
7 8 9  
0 Clear

Enter

Exit Menu Status Stop Flow

Waters e2695  
Separations Module

Waters

Waters  
THE SCIENCE OF WHAT'S POSSIBLE.™

[www.waters.com/alliance](http://www.waters.com/alliance)

alliance™

720006900EN

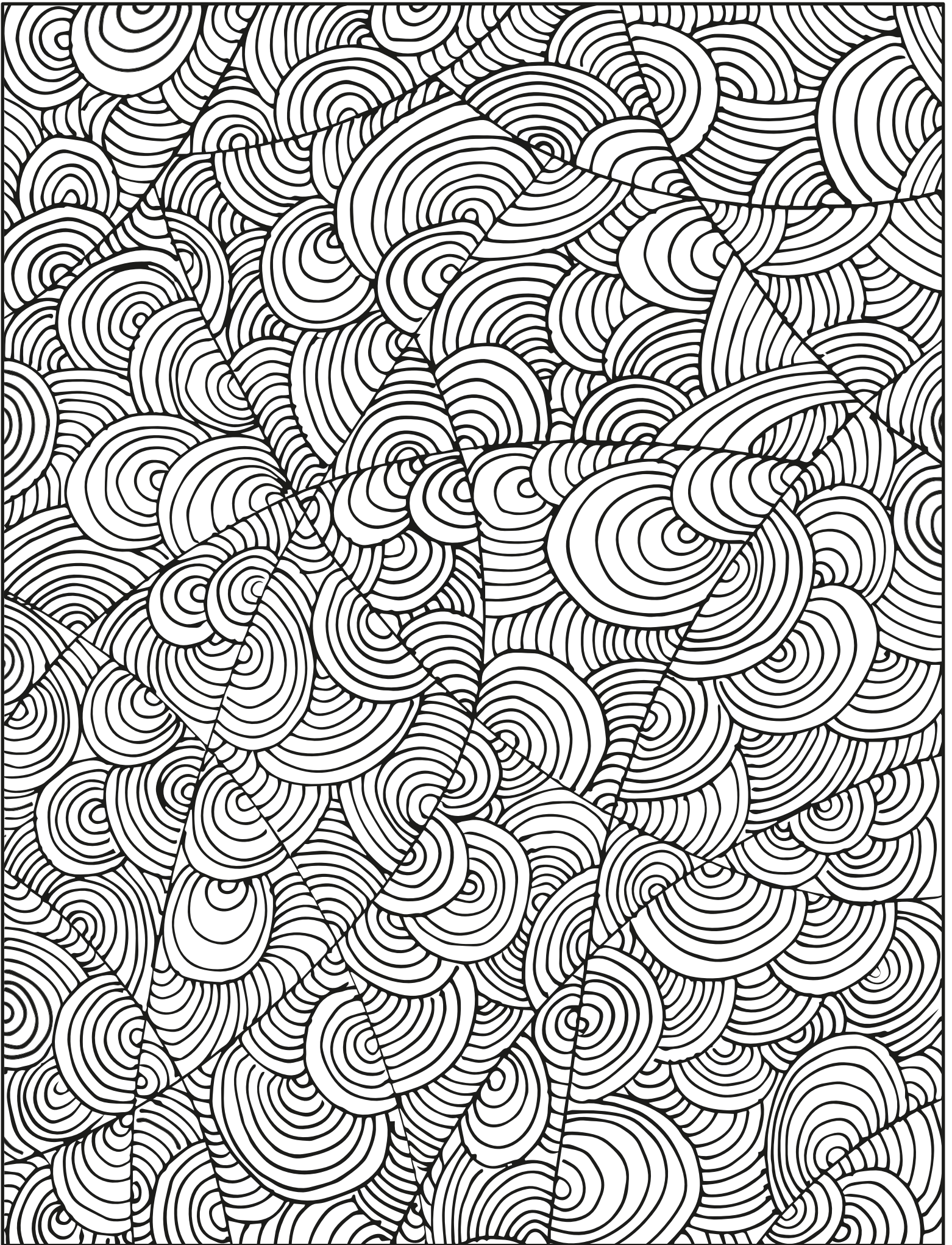



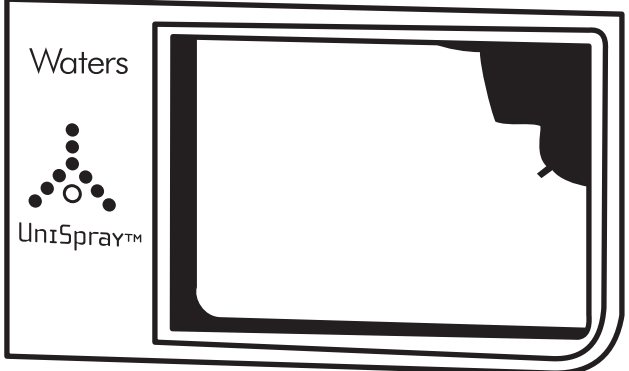
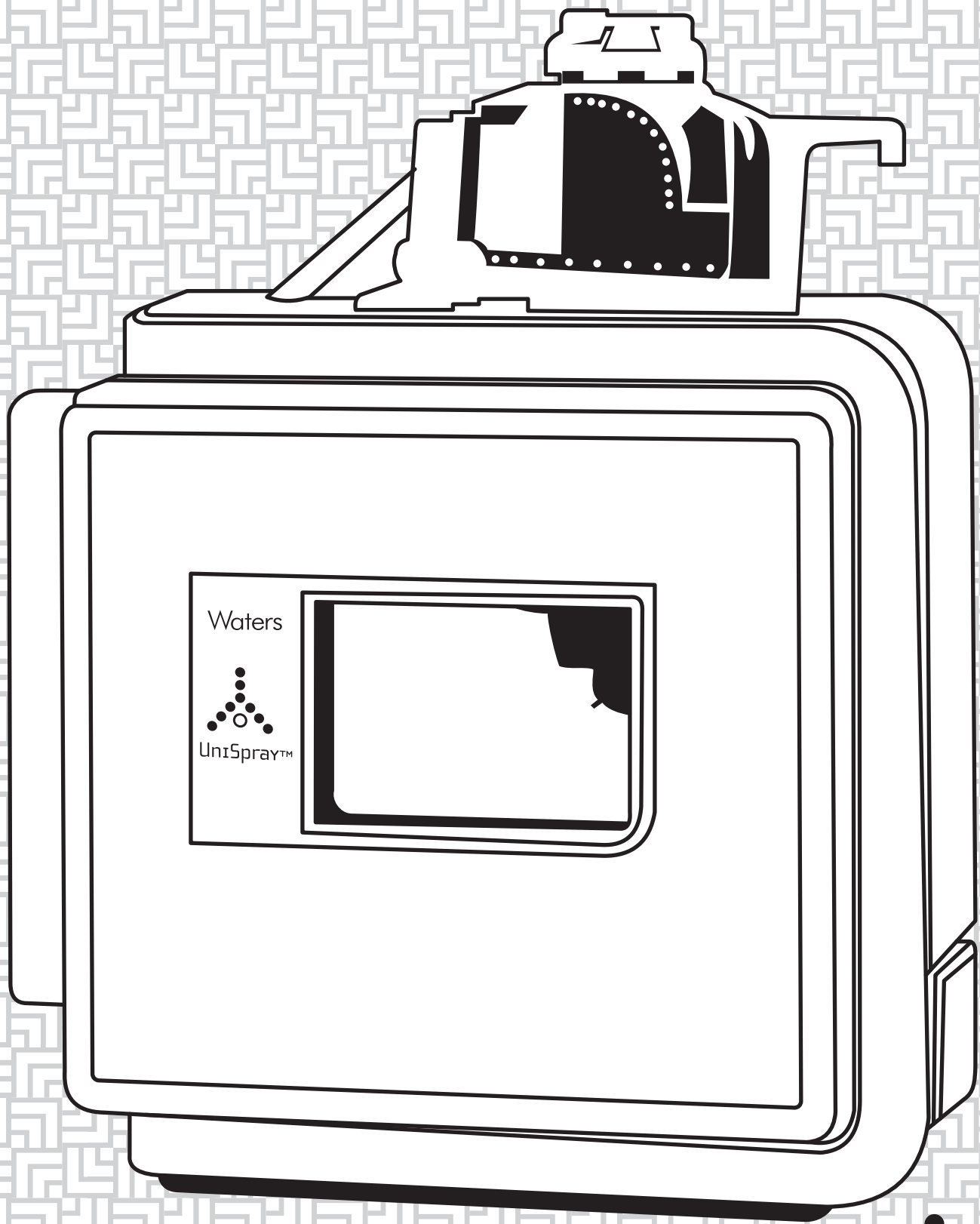

Waters

THE SCIENCE OF WHAT'S POSSIBLE.™

[www.waters.com/unispray](http://www.waters.com/unispray)



UniSpray™

720006842EN

For your local sales  
office, please visit  
[waters.com/contact](https://www.waters.com/contact)



**Waters Corporation**  
34 Maple Street  
Milford, MA 01757 U.S.A.  
T: 1 508 478 2000  
F: 1 508 872 1990  
[www.waters.com](https://www.waters.com)

# Waters

**THE SCIENCE OF WHAT'S POSSIBLE.™**

Waters, The Science of What's Possible, ACQUITY, UPLC, Arc, Alliance, CORTECS, Cyclic IMS, SELECT SERIES, SYNAPT, QDa, UniSpray, Vion, and Xevo are trademarks of Waters Corporation. All other trademarks are the property of their respective owners.

©2020 Waters Corporation. Produced in the U.S.A. May 2020 720006853EN LM-PDF